

KAPPA

9680TOO200P63

EAN 4031582315271

Swivel castor, housing and plate steel-welded, bright zinc plated, blue passivated, sealed single swivel double ball bearing, threaded king pin and locking nut secured, grease nipple, wheel axle with nut, plate fitting. Wheel centre made of Polyamide, heavy duty, plain bearing



BETTER MOBILITY. BETTER LIFE.



Picture may differ from original product

Technical Data

Wheel diameter	200 mm
Wheel width	50 mm
Castor width	110 mm
Size of Plate	135 x 110 mm
Plate hole centres	105 x 80/75 mm
Plate hole	11 mm
Dome-Ø	111 mm
Offset	59 mm
Swivel Interference	320 mm
Overall height	245 mm
Temperature	- 40 / + 80 °C
Standard	EN 12533
Weight	4.323 kg
Swivel Radius	160 mm
Hardness of tread	Shore D 75
Load capacity	1000 kg
Load capacity (static)	2000 kg

Advantages at a glance

Roll performance	● ● ● ● ●
Movement noise	● ○ ○ ○ ○
Attrition	● ● ● ● ●
Corrosion resistance	● ● ● ○ ○

Dimensions

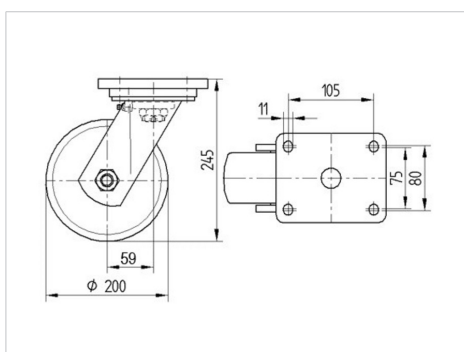

Structure & Mounting

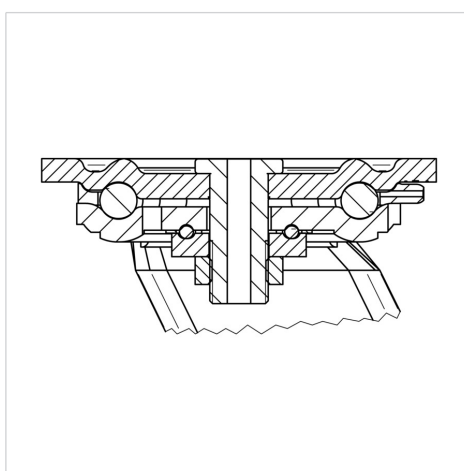

KAPPA

9680TOO200P63

EAN 4031582315271



BETTER MOBILITY. BETTER LIFE.

Structure & Mounting

