

# KAPPA

## 9680TOP160P63

EAN 4031582315325

Swivel caster, housing and plate steel-welded, bright zinc plated, blue passivated, sealed single swivel double ball bearing, threaded king pin and locking nut secured, grease nipple, wheel axle with nut, plate fitting. Wheel center made of Polyamide, heavy duty, precision ball bearing



BETTER MOBILITY. BETTER LIFE.



Picture may differ from original product

### Technical Data

Wheel diameter	160 mm
Wheel width	50 mm
Caster width	110 mm
Plate size	135 x 110 mm
Plate hole centers	105 x 80/75 mm
Plate hole	11 mm
Dome-Ø	111 mm
Offset	58 mm
Swivel Interference	280 mm
Overall height	205 mm
Temperature	- 30 / + 80 °C
Standard	EN 12533
Weight	4.111 kg
Swivel Radius	140 mm
Hardness of tread	Shore D 75
Load capacity (dynamic)	850 kg
Load capacity (static)	1700 kg

### Dimensions

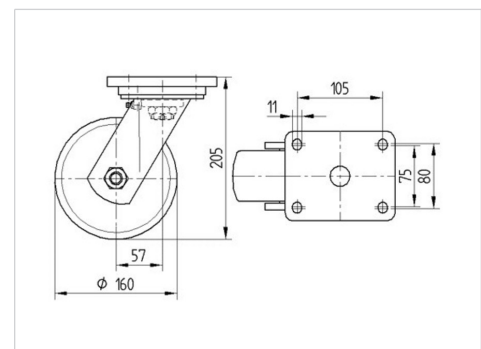

### Structure & Mounting

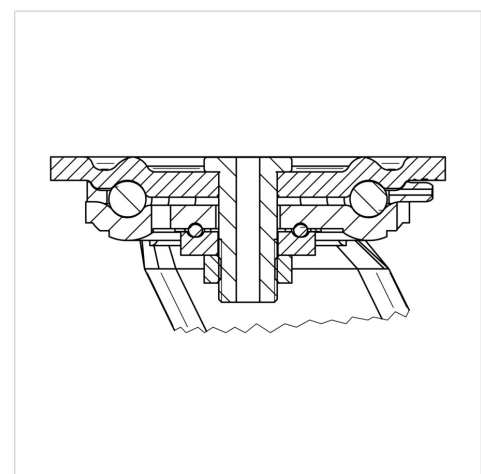

### Advantages at a glance

Roll performance	● ● ● ● ●
Movement noise	● ○ ○ ○ ○
Attrition	● ● ● ● ●
Corrosion resistance	● ● ● ○ ○

# KAPPA

9680TOP160P63

EAN 4031582315325



BETTER MOBILITY. BETTER LIFE.

## Structure & Mounting

