

KAPPA

9681TOP100P63

EAN 4031582315684

Swivel caster with directional lock, housing and plate steel-welded, bright zinc plated, blue passivated, sealed single swivel double ball bearing, threaded king pin and locking nut secured, grease nipple, wheel axle with nut, plate fitting. Wheel center made of Polyamide, heavy duty, precision ball bearing



BETTER MOBILITY. BETTER LIFE.



Picture may differ from original product

Technical Data

Wheel diameter	100 mm
Wheel width	50 mm
Caster width	110 mm
Plate size	135 x 110 mm
Plate hole centers	105 x 80/75 mm
Plate hole	11 mm
Dome-Ø	111 mm
Offset	41 mm
Swivel Interference	190 mm
Overall height	145 mm
Temperature	- 30 / + 80 °C
Standard	EN 12533
Weight	3.63 kg
Swivel Radius	95 mm
Hardness of tread	Shore D 75
Load capacity (dynamic)	600 kg
Load capacity (static)	1200 kg

Advantages at a glance

Roll performance	● ● ● ● ●
Movement noise	● ○ ○ ○ ○
Attrition	● ● ● ● ●
Corrosion resistance	● ● ● ○ ○

Dimensions

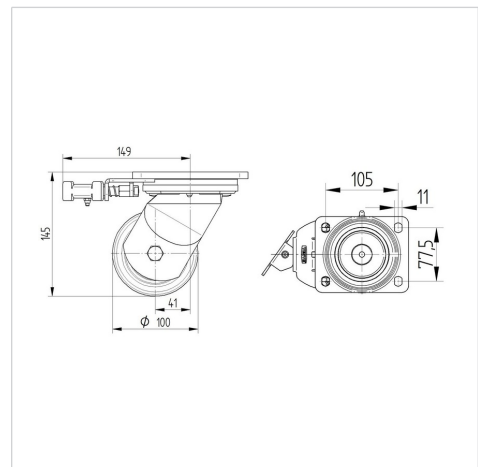

Structure & Mounting

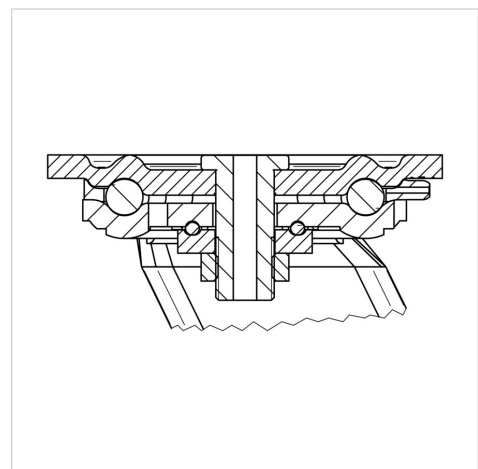

KAPPA

9681TOP100P63

EAN 4031582315684



BETTER MOBILITY. BETTER LIFE.

Structure & Mounting

