

KAPPA

9681TOP150P63

EAN 4031582315707

okretan tocak sa usmerenom kocnicom, Kuciste i ploca su zavareni, pocinkovani, zapezaceni dupli okretni kuglicni lezajevi ,lozovan klin , mazalica i osovina tocka sa maticom, Prikljucak ploca.. Telo tocka od poliamida, visoke nosivosti, precizni kuglicni lezaj

TENTE

BETTER MOBILITY. BETTER LIFE.



Picture may differ from original product

Tehnicki podaci

Precnik tocka.	150 mm
Sirina gazista.	50 mm
Sirina tocka	110 mm
Dimenzije ploce.	135 x 110 mm
Raspored rupa na ploci.	105 x 80/75 mm
Rupa na ploci.	11 mm
Kupola -Ø	111 mm
Dislokacija	58 mm
Otpor okretanju.	275 mm
Sveukupna visina.	200 mm
Temperatura	- 30 / + 80 °C
Standard	EN 12533
Tezina	4.252 kg
Radius okretanja	137.5 mm
Tvrdoca omotaca	Shore D 75
Dinamicka nosivost.	800 kg
Staticka nosivost.	1600 kg

Advantages at a glance

Otpor okretanju	● ● ● ● ●
Buka pri okretanju	● ○ ○ ○ ○
trenje , habanje	● ● ● ● ●
zastita od korozije	● ● ● ○ ○

Dimensions

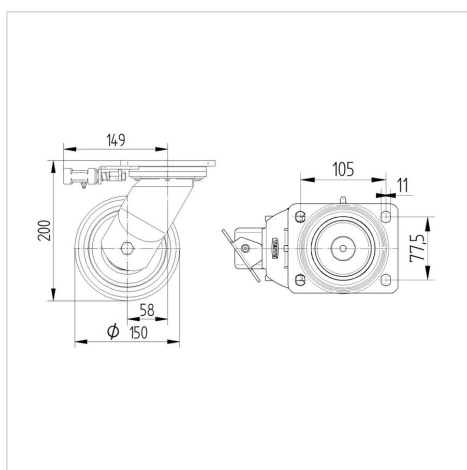

Structure & Mounting



KAPPA

9681TOP150P63

EAN 4031582315707



BETTER MOBILITY. BETTER LIFE.

Structure & Mounting

