

KAPPA

9682FTP125P63

EAN 4031582315745

Swivel caster with total lock, leading end of caster, housing and plate steel-welded, bright zinc plated, blue passivated, sealed single swivel double ball bearing, threaded king pin and locking nut secured, grease nipple, wheel axle with nut, plate fitting. Wheel center made of cast iron, Tread: Polyurethane, casted, precision ball bearing



BETTER MOBILITY. BETTER LIFE.



Picture may differ from original product

Technical Data

Wheel diameter	125 mm
Wheel width	50 mm
Caster width	116 mm
Plate size	135 x 110 mm
Plate hole centers	105 x 80/75 mm
Plate hole	11 mm
Dome-Ø	111 mm
Offset	48 mm
Swivel Interference	225 mm
Overall height	170 mm
Temperature	- 10 / + 60 °C
Standard	EN 12533
Weight	5.52 kg
Swivel Radius	112.5 mm
Hardness of tread	Shore D 42
Load capacity (dynamic)	550 kg
Load capacity (static)	1100 kg

Advantages at a glance

Roll performance	● ● ● ● ○
Movement noise	● ● ● ○ ○
Attrition	● ● ● ● ○
Corrosion resistance	● ● ● ○ ○

Dimensions

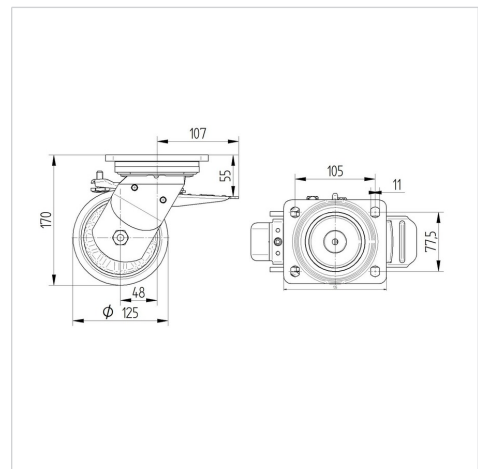

Structure & Mounting

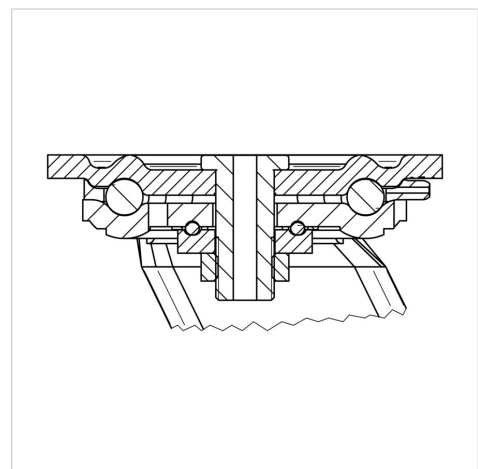

KAPPA

9682FTP125P63

EAN 4031582315745



BETTER MOBILITY. BETTER LIFE.

Structure & Mounting

