

KAPPA

9688FTP100P63

EAN 4031582316094

Fixed castor, Fork and plate steel welded, bright zinc plated, blue passivated, wheel axle with nut, plate fitting.
Wheel centre made of cast iron, Tread: Polyurethane, casted, precision ball bearing



BETTER MOBILITY. BETTER LIFE.



Picture may differ from original product

Technical Data

Wheel diameter	100 mm
Wheel width	50 mm
Castor width	98 mm
Size of Plate	135 x 110 mm
Plate hole centres	105 x 80/75 mm
Plate hole	11 mm
Dome-Ø	96 mm
Overall height	145 mm
Temperature	- 10 / + 60 °C
Standard	EN 12533
Weight	3.388 kg
Hardness of tread	Shore D 42
Load capacity	450 kg
Load capacity (static)	900 kg

Dimensions

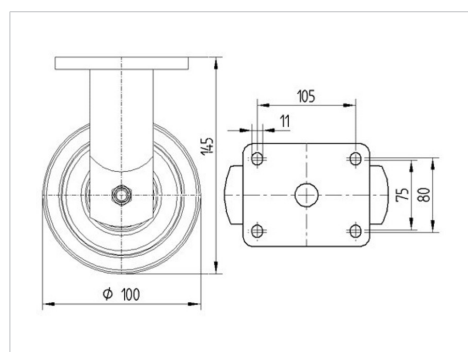

Advantages at a glance

Roll performance	● ● ● ● ○
Movement noise	● ● ● ○ ○
Attrition	● ● ● ● ○
Corrosion resistance	● ● ● ○ ○

KAPPA

9688FTP100P63

EAN 4031582316094



BETTER MOBILITY. BETTER LIFE.

Structure & Mounting

