

# KAPPA

9688FTP100P63

EAN 4031582316094

Fixed caster, Fork and plate steel welded, bright zinc plated, blue passivated, wheel axle with nut, plate fitting.  
Wheel center made of cast iron, Tread: Polyurethane, casted, precision ball bearing



BETTER MOBILITY. BETTER LIFE.



Picture may differ from original product

## Technical Data

Wheel diameter	100 mm
Wheel width	50 mm
Caster width	98 mm
Plate size	135 x 110 mm
Plate hole centers	105 x 80/75 mm
Plate hole	11 mm
Dome-Ø	96 mm
Overall height	145 mm
Temperature	- 10 / + 60 °C
Standard	EN 12533
Weight	3.388 kg
Hardness of tread	Shore D 42
Load capacity (dynamic)	450 kg
Load capacity (static)	900 kg

## Dimensions

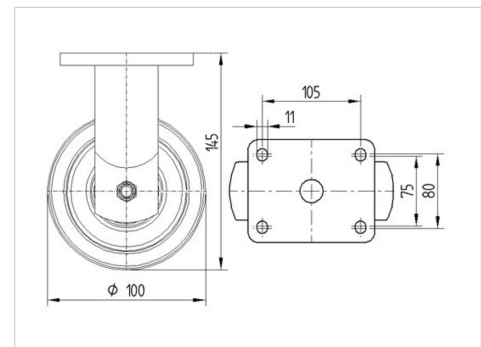

## Advantages at a glance

Roll performance	● ● ● ● ○
Movement noise	● ● ● ○ ○
Attrition	● ● ● ● ○
Corrosion resistance	● ● ● ○ ○

# KAPPA

9688FTP100P63

EAN 4031582316094



BETTER MOBILITY. BETTER LIFE.

## Structure & Mounting

