

KAPPA

9688FTP150P63 WT60

EAN 4031582316131

Faste hjul, Gaffel og montageplade af stålsvejt konstruktion, zink-kromatiseret, hjul boltet i gaffel

, befæstigelsesplade.

Hjulfælg: Støbegods, Hjulbane: Polyuretan, DIN-kugleleje



BETTER MOBILITY. BETTER LIFE.



Illustrationen kan afvige fra originalen

Tekniske data

Hjul-Ø	150 mm
Hjulbredde	60 mm
Hjulbredde	98 mm
Plademål	135 x 110 mm
Hulafstand	105 x 80/75 mm
Pladehul-Ø	11 mm
DOM-Ø	96 mm
Byggeøjde	200 mm
Temperaturinterval	- 10 / + 60 °C
Standard	EN 12533
Vægt	5.554 kg
Hjulbane hårdhed	Shore D 42
Belastning (dynamisk)	800 kg
Belastning (statisk)	1600 kg

Dimensioner

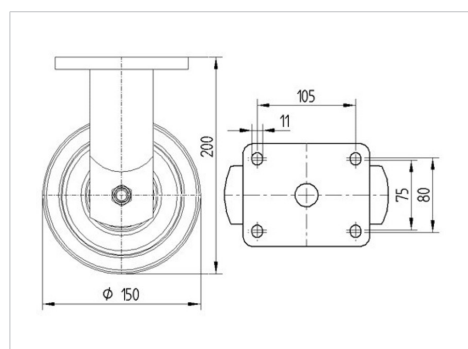

Egenskaber/fordele

Rullemodstand	● ● ● ● ○
Kørselsstøj	● ● ● ○ ○
Slid	● ● ● ● ○
Rustbeskyttelse	● ● ● ○ ○

KAPPA

9688FTP150P63 WT60

EAN 4031582316131



BETTER MOBILITY. BETTER LIFE.

Struktur og montering

