

# KAPPA

## 9688FTP250P63

EAN 4031582316261

Fiksirani točkić, Viljuska i ploča zavareni, pocinkovani, osovina tocka sa caurom, Priključak ploča..

Telo tocka napravljeno od livenog gvozdja, Omotac: poliuretan, precizni kuglicni lezaj

# TENTE

BETTER MOBILITY. BETTER LIFE.



Picture may differ from original product

### Tehnicki podaci

Precnik tocka.	250 mm
Sirina gazista.	50 mm
Sirina tocka	98 mm
Dimenzije ploce.	135 x 110 mm
Raspored rupa na ploci.	105 x 80/75 mm
Rupa na ploci.	11 mm
Kupola -Ø	96 mm
Sveukupna visina.	305 mm
Temperatura	- 10 / + 60 °C
Standard	EN 12533
Tezina	9.395 kg
Tvrdoca omotaca	Shore D 42
Dinamicka nosivost.	1200 kg
Staticka nosivost.	2400 kg

### Dimensions

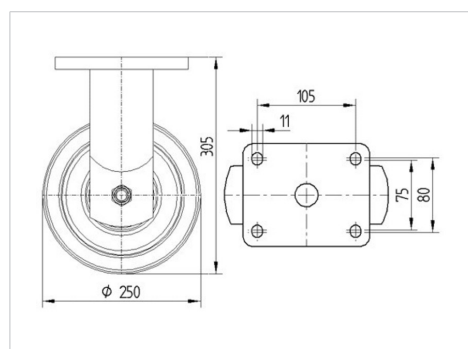

### Advantages at a glance

Otpor okretanju	● ● ● ● ○
Buka pri okretanju	● ● ● ○ ○
trenje , habanje	● ● ● ● ○
zastita od korozije	● ● ● ○ ○

# KAPPA

9688FTP250P63

EAN 4031582316261



BETTER MOBILITY. BETTER LIFE.

## Structure & Mounting

