

# KAPPA

9688IEP200P63

EAN 4031582316421

Fixed caster, Fork and plate steel welded, bright zinc plated, blue passivated, wheel axle with nut, plate fitting.  
Wheel center made of Aluminum, Tread: black elastic-tire, vulcanized, precision ball bearing



BETTER MOBILITY. BETTER LIFE.



Picture may differ from original product

## Technical Data

Wheel diameter	200 mm
Wheel width	50 mm
Caster width	98 mm
Plate size	135 x 110 mm
Plate hole centers	105 x 80/75 mm
Plate hole	11 mm
Dome-Ø	96 mm
Overall height	245 mm
Temperature	- 20 / + 85 °C
Standard	EN 12532
Weight	4.349 kg
Hardness of tread	Shore A 68
Load capacity (dynamic)	450 kg
Load capacity (static)	900 kg

## Dimensions

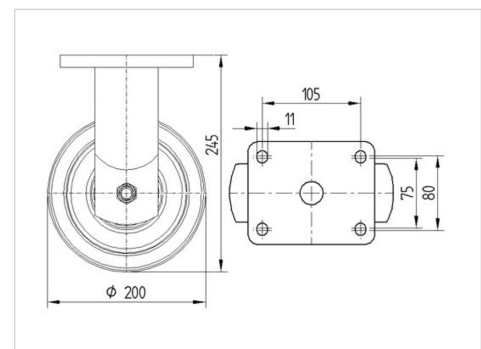

## Advantages at a glance

Roll performance	● ● ● ○ ○
Movement noise	● ● ● ● ●
Attrition	● ● ● ○ ○
Corrosion resistance	● ● ● ○ ○

# KAPPA

9688IEP200P63

EAN 4031582316421



BETTER MOBILITY. BETTER LIFE.

## Structure & Mounting

