

KAPPA

9688ITP125P63 Flat

EAN 4031582316452

Fiksirani točkić, Viljuska i ploca zavareni, pocinkovani, osovina tocka sa caurom, Priključak ploca..

Telo tocka od aluminijuma, Omotac: Poliuretan , liven, precizni kuglicni lezaj

TENTE

BETTER MOBILITY. BETTER LIFE.



Picture may differ from original product

Tehnicki podaci

Precnik tocka.	125 mm
Sirina gazista.	50 mm
Sirina tocka	98 mm
Dimenzije ploce.	135 x 110 mm
Raspored rupa na ploci.	105 x 80/75 mm
Rupa na ploci.	11 mm
Kupola -Ø	96 mm
Sveukupna visina.	170 mm
Temperatura	- 10 / + 60 °C
Standard	EN 12532
Tezina	1.73 kg
Tvrdoca omotaca	Shore D 42
Dinamicka nosivost.	500 kg
Staticka nosivost.	1000 kg

Dimensions

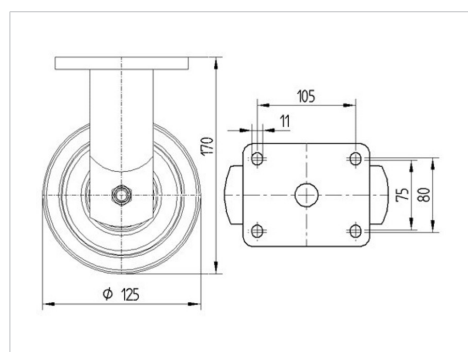

Advantages at a glance

Otpor okretanju	● ● ● ● ○
Buka pri okretanju	● ● ● ○ ○
trenje , habanje	● ● ● ● ○
zastita od korozije	● ● ● ○ ○

KAPPA

9688ITP125P63 Flat

EAN 4031582316452



BETTER MOBILITY. BETTER LIFE.

Structure & Mounting

