

KAPPA

9688ITP200P63 Flat

EAN 4031582316506

Fixed caster, Fork and plate steel welded, bright zinc plated, blue passivated, wheel axle with nut, plate fitting.
Wheel center made of Aluminum, Tread: Polyurethane, casted, precision ball bearing



BETTER MOBILITY. BETTER LIFE.



Picture may differ from original product

Technical Data

Wheel diameter	200 mm
Wheel width	50 mm
Caster width	98 mm
Plate size	135 x 110 mm
Plate hole centers	105 x 80/75 mm
Plate hole	11 mm
Dome-Ø	96 mm
Overall height	245 mm
Temperature	- 10 / + 60 °C
Standard	EN 12532
Weight	3.308 kg
Hardness of tread	Shore D 42
Load capacity (dynamic)	800 kg
Load capacity (static)	1600 kg

Dimensions

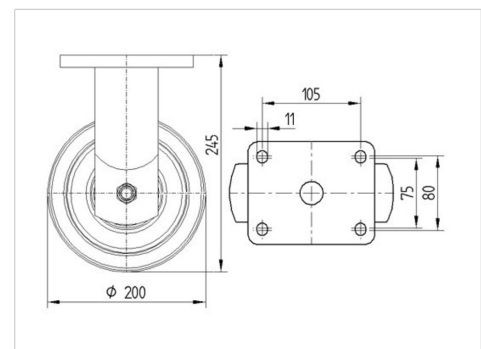

Advantages at a glance

Roll performance	● ● ● ● ○
Movement noise	● ● ● ○ ○
Attrition	● ● ● ● ○
Corrosion resistance	● ● ● ○ ○

KAPPA

9688ITP200P63 Flat

EAN 4031582316506



BETTER MOBILITY. BETTER LIFE.

Structure & Mounting

