

KAPPA

9688TOO100P63

EAN 4031582316544

Fiksirani točkić, Viljuska i ploca zavareni, pocinkovani, osovina tocka sa caurom, Priključak ploca..

Telo tocka od poliamida, visoke nosivosti, obican lezaj

TENTE

BETTER MOBILITY. BETTER LIFE.



Picture may differ from original product

Tehnicki podaci

Precnik tocka.	100 mm
Sirina gazista.	50 mm
Sirina tocka	98 mm
Dimenzije ploce.	135 x 110 mm
Raspored rupa na ploci.	105 x 80/75 mm
Rupa na ploci.	11 mm
Kupola -Ø	96 mm
Sveukupna visina.	145 mm
Temperatura	- 40 / + 80 °C
Standard	EN 12533
Tezina	2.627 kg
Tvrdoca omotaca	Shore D 75
Dinamicka nosivost.	600 kg
Staticka nosivost.	1200 kg

Dimensions

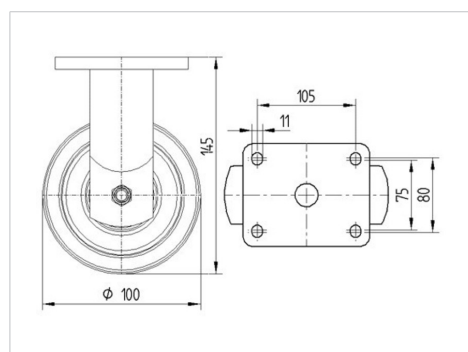

Advantages at a glance

Otpor okretanju	● ● ● ● ○
Buka pri okretanju	● ○ ○ ○ ○
trenje , habanje	● ● ● ● ●
zastita od korozije	● ● ● ○ ○

KAPPA

9688TOO100P63

EAN 4031582316544



BETTER MOBILITY. BETTER LIFE.

Structure & Mounting

