

KAPPA

9688TOO160P63

EAN 4031582316582

Faste hjul, Gaffel og montageplade af stålsvejt konstruktion, zink-kromatiseret, hjul boltet i gaffel, befæstigelsesplade.
Hjulfælg: Polyamid, svær udførelse, glideleje



BETTER MOBILITY. BETTER LIFE.



Illustrationen kan afvige fra originalen

Tekniske data

Hjul-Ø	160 mm
Hjulbredde	50 mm
Plademål	135 x 110 mm
Hulafstand	105 x 80/75 mm
Pladehul-Ø	11 mm
Byggehøjde	205 mm
Temperaturinterval	- 40 / + 80 °C
Standard	EN 12533
Vægt	2.813 kg
Hjulbane hårdhed	Shore D 75
Belastning (dynamisk)	850 kg
Belastning (statisk)	1700 kg

Dimensioner

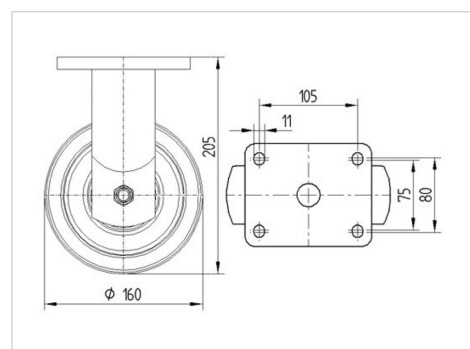

Egenskaber/fordele

Rullemodstand	● ● ● ● ○
Kørselsstøj	● ○ ○ ○ ○
Slid	● ● ● ● ●
Rustbeskyttelse	● ● ● ○ ○

KAPPA

9688TOO160P63

EAN 4031582316582



BETTER MOBILITY. BETTER LIFE.

Struktur og montering

