

KAPPA

9688TOO160P63

EAN 4031582316582

Fixed castor, Fork and plate steel welded, bright zinc plated, blue passivated, wheel axle with nut, plate fitting.

Wheel centre made of Polyamide, heavy duty, plain bearing



BETTER MOBILITY. BETTER LIFE.



Picture may differ from original product

Technical Data

Wheel diameter	160 mm
Wheel width	50 mm
Size of Plate	135 x 110 mm
Plate hole centres	105 x 80/75 mm
Plate hole	11 mm
Overall height	205 mm
Temperature	- 40 / + 80 °C
Standard	EN 12533
Weight	2.813 kg
Hardness of tread	Shore D 75
Load capacity	850 kg
Load capacity (static)	1700 kg

Dimensions

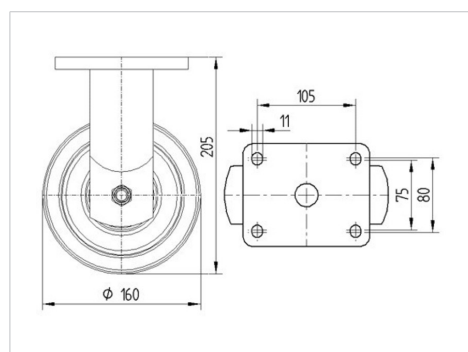

Advantages at a glance

Roll performance	● ● ● ● ○
Movement noise	● ○ ○ ○ ○
Attrition	● ● ● ● ●
Corrosion resistance	● ● ● ○ ○

KAPPA

9688TOO160P63

EAN 4031582316582



BETTER MOBILITY. BETTER LIFE.

Structure & Mounting

