

# KAPPA

## 9688TOP100P63

EAN 4031582316643

Fixed caster, Fork and plate steel welded, bright zinc plated, blue passivated, wheel axle with nut, plate fitting.  
Wheel center made of Polyamide, heavy duty, precision ball bearing



BETTER MOBILITY. BETTER LIFE.



Picture may differ from original product

### Technical Data

Wheel diameter	100 mm
Wheel width	50 mm
Caster width	98 mm
Plate size	135 x 110 mm
Plate hole centers	105 x 80/75 mm
Plate hole	11 mm
Dome-Ø	96 mm
Overall height	145 mm
Temperature	- 30 / + 80 °C
Standard	EN 12533
Weight	2.797 kg
Hardness of tread	Shore D 75
Load capacity (dynamic)	600 kg
Load capacity (static)	1200 kg

### Dimensions

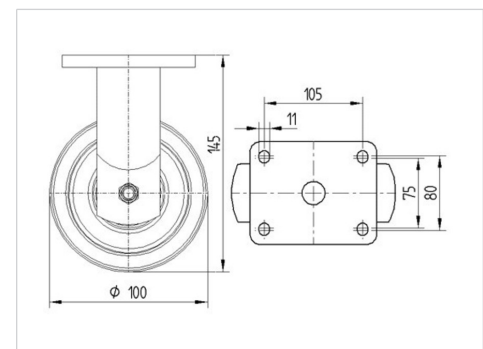

### Advantages at a glance

Roll performance	● ● ● ● ●
Movement noise	● ○ ○ ○ ○
Attrition	● ● ● ● ●
Corrosion resistance	● ● ● ○ ○

# KAPPA

9688TOP100P63

EAN 4031582316643



BETTER MOBILITY. BETTER LIFE.

## Structure & Mounting

