

# KAPPA

## 9688TOP125P63

EAN 4031582316650

Fiksirani točkić, Viljuska i ploca zavareni, pocinkovani, osovina tocka sa caurom, Priključak ploca..

Telo tocka od poliamida, visoke nosivosti, precizni kuglicni lezaj

**TENTE**

BETTER MOBILITY. BETTER LIFE.



Picture may differ from original product

### Tehnicki podaci

Precnik tocka.	125 mm
Sirina gazista.	50 mm
Sirina tocka	98 mm
Dimenzije ploce.	135 x 110 mm
Raspored rupa na ploci.	105 x 80/75 mm
Rupa na ploci.	11 mm
Kupola -Ø	96 mm
Sveukupna visina.	170 mm
Temperatura	- 30 / + 80 °C
Standard	EN 12533
Tezina	1.731 kg
Tvrdoca omotaca	Shore D 75
Dinamicka nosivost.	700 kg
Staticka nosivost.	1400 kg

### Dimensions

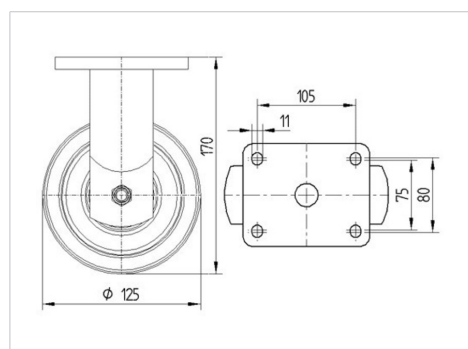

### Advantages at a glance

Otpor okretanju	● ● ● ● ●
Buka pri okretanju	● ○ ○ ○ ○
trenje , habanje	● ● ● ● ●
zastita od korozije	● ● ● ○ ○

# KAPPA

9688TOP125P63

EAN 4031582316650



BETTER MOBILITY. BETTER LIFE.

## Structure & Mounting

