

KAPPA

9688TOP250P63

EAN 4031582316728

Fixed castor, Fork and plate steel welded, bright zinc plated, blue passivated, wheel axle with nut, plate fitting.
Wheel centre made of Polyamide, heavy duty, precision ball bearing



BETTER MOBILITY. BETTER LIFE.



Picture may differ from original product

Technical Data

Wheel diameter	250 mm
Wheel width	50 mm
Castor width	98 mm
Size of Plate	135 x 110 mm
Plate hole centres	105 x 80/75 mm
Plate hole	11 mm
Dome-Ø	96 mm
Overall height	305 mm
Temperature	- 30 / + 80 °C
Standard	EN 12533
Weight	4.696 kg
Hardness of tread	Shore D 75
Load capacity	1100 kg
Load capacity (static)	2200 kg

Dimensions

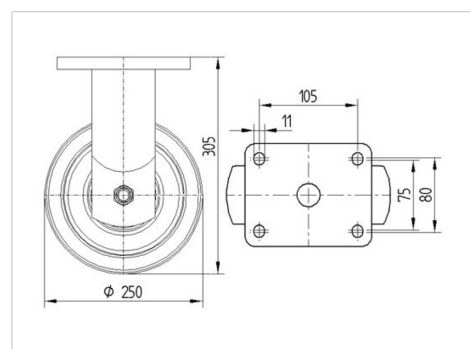

Advantages at a glance

Roll performance	● ● ● ● ●
Movement noise	● ○ ○ ○ ○
Attrition	● ● ● ● ●
Corrosion resistance	● ● ● ○ ○

KAPPA

9688TOP250P63

EAN 4031582316728



BETTER MOBILITY. BETTER LIFE.

Structure & Mounting

