

OMIKRON TWIN

9950TOP200P65

EAN 4031582316902

Swivel caster, housing and plate steel-welded, zinc plated, blue passivated, sealed swivel bearing with dual purpose bearing and tapered roller bearing, threaded king pin and locking nut secured, grease nipple, wheel axle with nut, plate fitting. Wheel center made of Polyamide, heavy duty, precision ball bearing



BETTER MOBILITY. BETTER LIFE.



Picture may differ from original product

Technical Data

Wheel diameter	200 mm
Wheel width	50 mm
Caster width	189 mm
Plate size	200 x 160 mm
Plate hole centers	160 x 120 mm
Plate hole	15 mm
Dome-Ø	160 mm
Offset	60 mm
Swivel Interference	332 mm
Overall height	275 mm
Temperature	- 40 / + 85 °C
Standard	EN 12533
Weight	16.822 kg
Swivel Radius	166 mm
Hardness of tread	Shore D 75
Load capacity (dynamic)	2400 kg
Load capacity (static)	4800 kg

Advantages at a glance

Roll performance	● ● ● ● ●
Movement noise	● ● ● ○ ○
Attrition	● ● ● ● ●
Corrosion resistance	● ● ● ○ ○

Dimensions

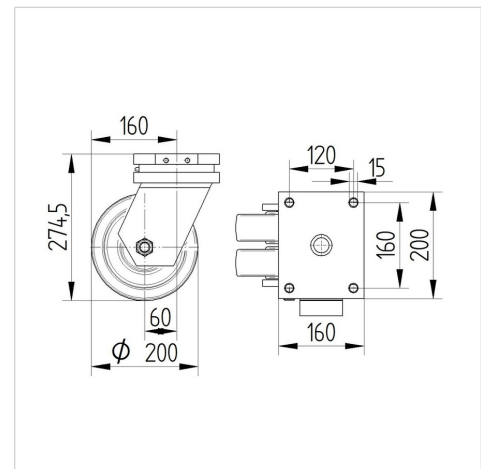

Structure & Mounting

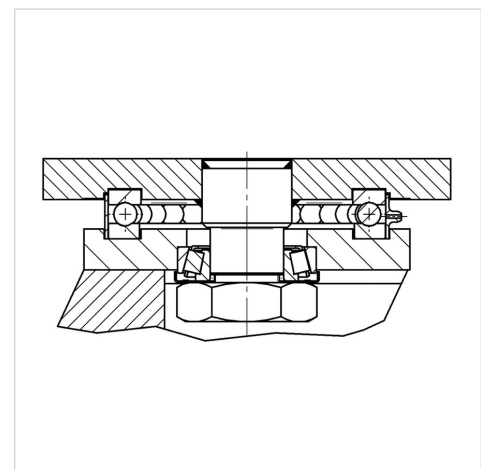

OMIKRON TWIN

9950TOP200P65

EAN 4031582316902



BETTER MOBILITY. BETTER LIFE.

Structure & Mounting

