

OMIKRON TWIN

9958FTP100P65

EAN 4031582316926

Fixed caster, Fork and plate steel welded, zinc plated, blue passivated, wheel axle with nut, plate fitting.

Wheel center made of cast iron, Tread: Polyurethane, casted, precision ball bearing



BETTER MOBILITY. BETTER LIFE.



Picture may differ from original product

Technical Data

Wheel diameter	100 mm
Wheel width	50 mm
Caster width	189 mm
Plate size	200 x 160 mm
Plate hole centers	160 x 120 mm
Plate hole	15 mm
Dome-Ø	160 mm
Overall height	180 mm
Temperature	- 10 / + 60 °C
Standard	EN 12533
Weight	9.943 kg
Hardness of tread	Shore D 42
Load capacity (dynamic)	1080 kg
Load capacity (static)	2160 kg

Dimensions

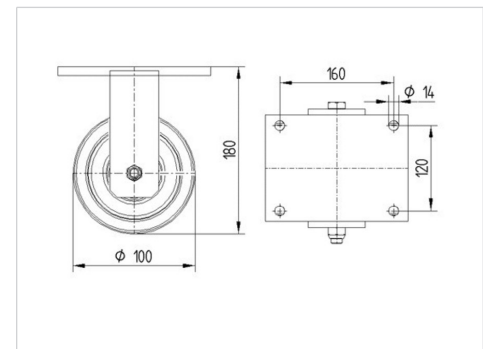

Advantages at a glance

Roll performance	● ● ● ● ○
Movement noise	● ● ● ○ ○
Attrition	● ● ● ● ○
Corrosion resistance	● ● ● ○ ○

OMIKRON TWIN

9958FTP100P65

EAN 4031582316926



BETTER MOBILITY. BETTER LIFE.

Structure & Mounting

