

# OMIKRON TWIN

## 9958FTP200P68

EAN 4031582316971

Fiksirani točkić, Viljuska i ploca zavareni, pocinkovani, osovina tocka sa caurom, Priključak ploca..

Telo tocka napravljeno od livenog gvozdja, Omotac: poliuretan, precizni kuglicni lezaj

# TENTE

BETTER MOBILITY. BETTER LIFE.



Picture may differ from original product

### Tehnicki podaci

Precnik tocka.	200 mm
Sirina gazista.	80 mm
Sirina tocka	272 mm
Dimenzije ploce.	270 x 250 mm
Raspored rupa na ploci.	230 x 210 mm
Rupa na ploci.	17 mm
Kupola -Ø	235 mm
Sveukupna visina.	315 mm
Temperatura	- 10 / + 60 °C
Standard	EN 12533
Tezina	30.348 kg
Tvrdoca omotaca	Shore D 42
Dinamicka nosivost.	2800 kg
Staticka nosivost.	5600 kg

### Dimensions

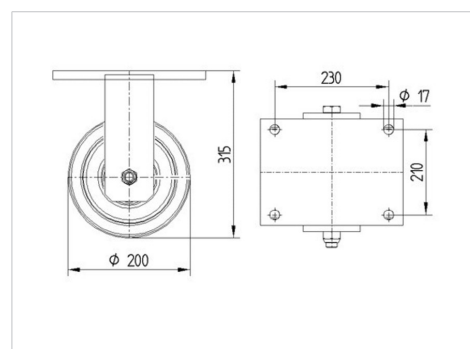

### Advantages at a glance

Otpor okretanju	● ● ● ● ○
Buka pri okretanju	● ● ● ○ ○
trenje , habanje	● ● ● ● ○
zastita od korozije	● ● ● ○ ○

# OMIKRON TWIN

9958FTP200P68

EAN 4031582316971



BETTER MOBILITY. BETTER LIFE.

## Structure & Mounting

