

# OMIKRON TWIN

## 9958FTP250P65

EAN 4031582316988

Fiksirani točkić, Viljuska i ploca zavareni, pocinkovani, osovina tocka sa caurom, Priključak ploca..

Telo tocka napravljeno od livenog gvozdja, Omotac: poliuretan, precizni kuglicni lezaj

# TENTE

BETTER MOBILITY. BETTER LIFE.



Picture may differ from original product

### Tehnicki podaci

Precnik tocka.	250 mm
Sirina gazista.	50 mm
Sirina tocka	154 mm
Dimenzije ploce.	200 x 160 mm
Raspored rupa na ploci.	160 x 120 mm
Rupa na ploci.	15 mm
Kupola -Ø	160 mm
Sveukupna visina.	325 mm
Temperatura	- 10 / + 60 °C
Standard	EN 12533
Tezina	21.11 kg
Tvrdoca omotaca	Shore D 42
Dinamicka nosivost.	2880 kg
Staticka nosivost.	5760 kg

### Dimensions

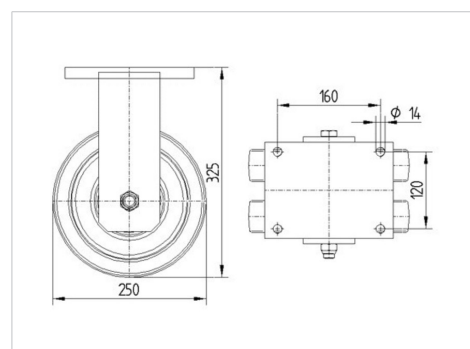

### Advantages at a glance

Otpor okretanju	● ● ● ● ○
Buka pri okretanju	● ● ● ○ ○
trenje , habanje	● ● ● ● ○
zastita od korozije	● ● ● ○ ○

# OMIKRON TWIN

9958FTP250P65

EAN 4031582316988



BETTER MOBILITY. BETTER LIFE.

## Structure & Mounting

