

# OMIKRON TWIN

9958FTP250P68

EAN 4031582316995

Fixed caster, Fork and plate steel welded, zinc plated, blue passivated, wheel axle with nut, plate fitting.

Wheel center made of cast iron, Tread: Polyurethane, casted, precision ball bearing



BETTER MOBILITY. BETTER LIFE.



Picture may differ from original product

## Technical Data

Wheel diameter	250 mm
Wheel width	80 mm
Caster width	272 mm
Plate size	270 x 250 mm
Plate hole centers	230 x 210 mm
Plate hole	17 mm
Dome-Ø	235 mm
Overall height	365 mm
Temperature	- 10 / + 60 °C
Standard	EN 12533
Weight	38.319 kg
Hardness of tread	Shore D 42
Load capacity (dynamic)	4320 kg
Load capacity (static)	8640 kg

## Dimensions

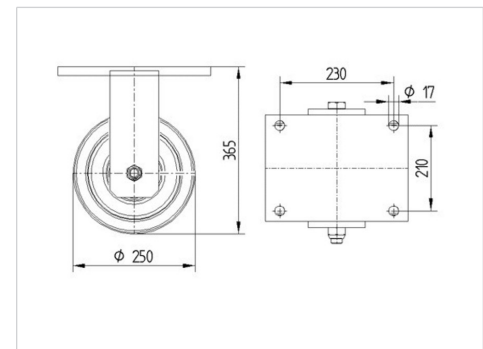

## Advantages at a glance

Roll performance	● ● ● ● ○
Movement noise	● ● ● ○ ○
Attrition	● ● ● ● ○
Corrosion resistance	● ● ● ○ ○

# OMIKRON TWIN

9958FTP250P68

EAN 4031582316995



BETTER MOBILITY. BETTER LIFE.

## Structure & Mounting

