

OMIKRON TWIN

9958FTP400P68

EAN 4031582317022

Faste hjul, Gaffel og montageplade af stålsvejt konstruktion, zink-kromatiseret, hjul boltet i gaffel, befæstigelsesplade.

Hjulfælg: Støbegods, Hjulbane: Polyuretan, DIN-kugleleje



BETTER MOBILITY. BETTER LIFE.



Illustrationen kan afvige fra originalen

Tekniske data

Hjul-Ø	400 mm
Hjulbredde	80 mm
Hjulbredde	285 mm
Plademål	270 x 250 mm
Hulafstand	230 x 210 mm
Pladehul-Ø	17 mm
DOM-Ø	235 mm
Byggehøjde	510 mm
Temperaturinterval	- 10 / + 60 °C
Standard	EN 12533
Vægt	71.436 kg
Hjulbane hårdhed	Shore D 42
Belastning (dynamisk)	6000 kg
Belastning (statisk)	12000 kg

Dimensioner

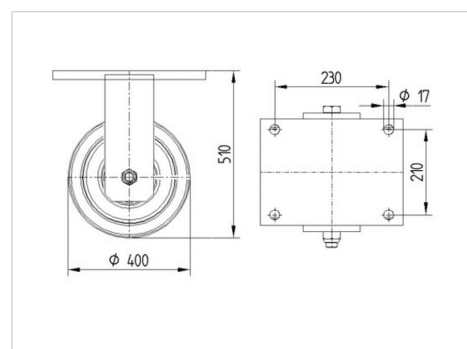

Egenskaber/fordele

Rullemodstand	● ● ● ● ○
Kørselsstøj	● ● ● ○ ○
Slid	● ● ● ● ○
Rustbeskyttelse	● ● ● ○ ○

OMIKRON TWIN

9958FTP400P68

EAN 4031582317022



BETTER MOBILITY. BETTER LIFE.

Struktur og montering

