

OMIKRON TWIN

9958TOP100P65

EAN 4031582317046

Fixed castor, Fork and plate steel welded, zinc plated, blue passivated, wheel axle with nut, plate fitting.

Wheel centre made of Polyamide, heavy duty, precision ball bearing



BETTER MOBILITY. BETTER LIFE.



Picture may differ from original product

Technical Data

Wheel diameter	100 mm
Wheel width	50 mm
Castor width	189 mm
Size of Plate	200 x 160 mm
Plate hole centres	160 x 120 mm
Plate hole	15 mm
Dome-Ø	160 mm
Overall height	180 mm
Temperature	- 40 / + 85 °C
Standard	EN 12533
Weight	7.225 kg
Hardness of tread	Shore D 75
Load capacity	1440 kg
Load capacity (static)	2880 kg

Dimensions

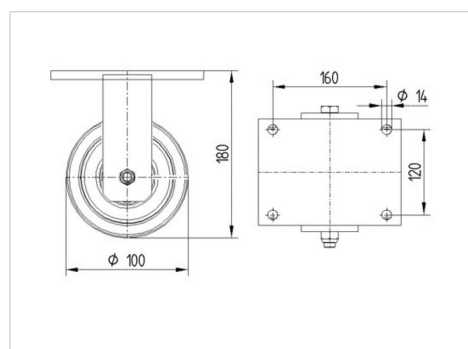

Advantages at a glance

Roll performance	● ● ● ● ●
Movement noise	● ● ● ○ ○
Attrition	● ● ● ● ●
Corrosion resistance	● ● ● ○ ○

OMIKRON TWIN

9958TOP100P65

EAN 4031582317046



BETTER MOBILITY. BETTER LIFE.

Structure & Mounting

