

OMIKRON TWIN

9958TOP250P65

EAN 4031582317091

Fixed caster, Fork and plate steel welded, zinc plated, blue passivated, wheel axle with nut, plate fitting.

Wheel center made of Polyamide, heavy duty, precision ball bearing



BETTER MOBILITY. BETTER LIFE.



Picture may differ from original product

Technical Data

Wheel diameter	250 mm
Wheel width	50 mm
Caster width	192 mm
Plate size	200 x 160 mm
Plate hole centers	160 x 120 mm
Plate hole	15 mm
Dome-Ø	160 mm
Overall height	325 mm
Temperature	- 40 / + 85 °C
Standard	EN 12533
Weight	11.712 kg
Hardness of tread	Shore D 75
Load capacity (dynamic)	2640 kg
Load capacity (static)	5280 kg

Dimensions

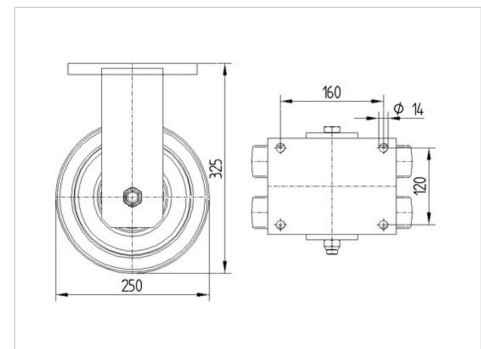

Advantages at a glance

Roll performance	● ● ● ● ●
Movement noise	● ● ● ○ ○
Attrition	● ● ● ● ●
Corrosion resistance	● ● ● ○ ○

OMIKRON TWIN

9958TOP250P65

EAN 4031582317091



BETTER MOBILITY. BETTER LIFE.

Structure & Mounting

