

PURETECH

DIK100x32-Ø8

EAN 4031582070156

Wheel center made of pressed steel, Tread: solid rubber, grey non-marking, with threadguards, cone ball bearing



BETTER MOBILITY. BETTER LIFE.



Picture may differ from original product

Technical Data

Wheel diameter	100 mm
Wheel width	32 mm
Axle Hole-Ø	8 mm
Hub length	36 mm
Temperature	- 20 / + 85 °C
Standard	EN 12530
Weight	0.444 kg
Hardness of tread	Shore A 80
Load capacity (dynamic)	80 kg
Load capacity (static)	160 kg

Dimensions

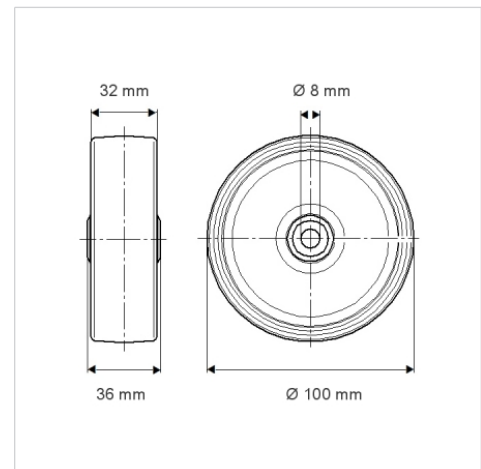

Advantages at a glance

Roll performance	● ● ● ○ ○
Movement noise	● ● ● ○ ○
Attrition	● ● ● ○ ○
Corrosion resistance	● ● ● ○ ○