

PURETECH

DVR100x30-Ø12

EAN 4031582070057

Wheel centre made of pressed steel, Tread: solid rubber, black, roller bearing



BETTER MOBILITY. BETTER LIFE.



Picture may differ from original product

Technical Data

Wheel diameter	100 mm
Wheel width	30 mm
Axle Hole-Ø	12 mm
Hub length	44.4 mm
Temperature	- 20 / + 85 °C
Standard	EN 12532
Weight	0.272 kg
Hardness of tread	Shore A 80
Load capacity	70 kg
Load capacity (static)	140 kg

Dimensions

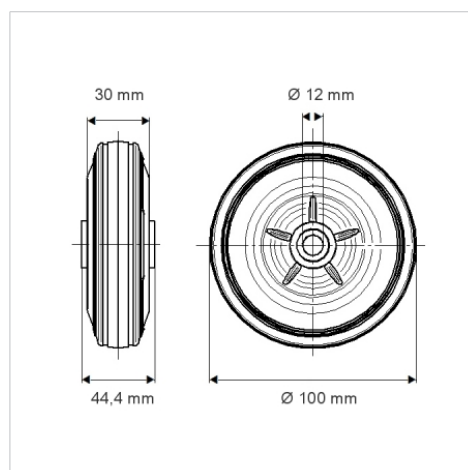

Advantages at a glance

Roll performance	● ● ● ○ ○
Movement noise	● ● ● ○ ○
Attrition	● ● ○ ○ ○
Corrosion resistance	● ● ● ○ ○