

PURETECH

DVR100x30-Ø12

EAN 4031582070057

Telo točka je napravljeno od presovanog celika. Omotac: cvrsta crna guma, valjkasti lezaj.

TENTE

BETTER MOBILITY. BETTER LIFE.



Picture may differ from original product

Tehnicki podaci

Precnik tocka.	100 mm
Sirina gazista.	30 mm
Otvor za osovinu Ø	12 mm
Duzina glavcine.	44.4 mm
Temperatura	- 20 / + 85 °C
Standard	EN 12532
Tezina	0.272 kg
Tvrdoca omotaca	Shore A 80
Dinamicka nosivost.	70 kg
Staticka nosivost.	140 kg

Dimensions

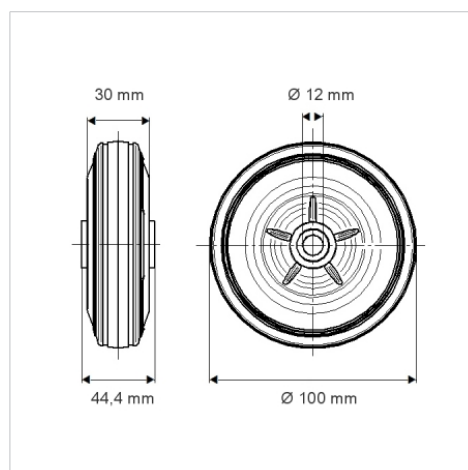

Advantages at a glance

Otpor okretanju	● ● ● ○ ○
Buka pri okretanju	● ● ● ○ ○
trenje , habanje	● ● ○ ○ ○
zastita od korozije	● ● ● ○ ○