

PURETECH

DYK075x25-Ø6

EAN 4031582318234

Hjulfælg: Stål, Hjulbane: Massiv sort gummi, elektrisk ledende, konuskugleleje, med trådfang



BETTER MOBILITY. BETTER LIFE.



Illustrationen kan afvige fra originalen

Tekniske data

Hjul-Ø	75 mm
Hjulbredde	25 mm
Boring-Ø	6 mm
Navlængde	28 mm
Temperaturinterval	- 20 / + 85 °C
Standard	EN 12530
Vægt	0.198 kg
Hjulbane hårdhed	Shore A 80
Belastning (dynamisk)	55 kg
Belastning (statisk)	110 kg

Dimensioner

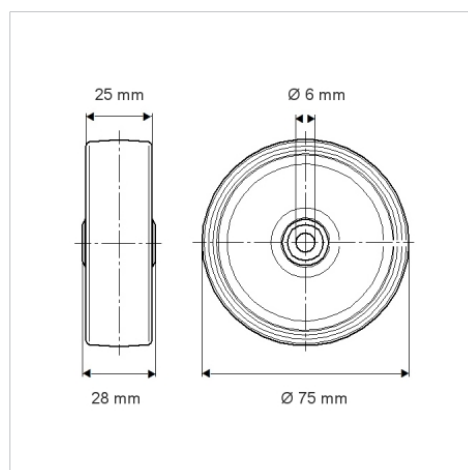

Egenskaber/fordele

Rullemodstand	● ● ● ○ ○
Kørselsstøj	● ● ● ○ ○
Slid	● ● ● ○ ○
Rustbeskyttelse	● ● ● ○ ○