

NOVATECH

FTP100x50-Ø20 HL60

EAN 4031582329391

주철로 만든 휠 중심, 트레드: 폴리우레탄, 주조 처리, 정밀 볼 베어링



BETTER MOBILITY. BETTER LIFE.



Picture may differ from original product

기술 데이터

휠 직경	100 mm
휠 폭	50 mm
축 홀-Ø	20 mm
허브 길이	60 mm
온도	- 10 / + 60 °C
표준	EN 12533
무게	1.668 kg
트레드 경도	Shore D 42
동하중	450 kg
정지하중	900 kg

Dimensions

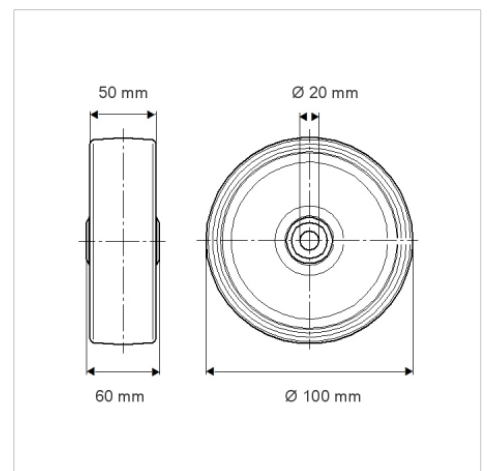

Advantages at a glance

롤 저항성	● ● ● ● ○
이동 소음	● ● ● ○ ○
마찰	● ● ● ● ○
부식 방지	● ● ● ○ ○

Structure & Mounting

