

NOVATECH

FTP150x50-Ø25 HL60

EAN 4031582329476

Jantă din fontă, suprafață de rulare din poliuretan turnat, rulment cu bile

TENTE

BETTER MOBILITY. BETTER LIFE.



Picture may differ from original product

Date Tehnice

Diametrul roții	150 mm
Lățimea roții	50 mm
Alezaj butuc	25 mm
Lungime butuc	60 mm
Temperatura	- 10 / + 60 °C
Standard	EN 12533
Greutate	3.564 kg
Rigiditatea suprafeței de rulare	Shore D 42
Sarcină dinamică	700 kg
Sarcină statică	1400 kg

Dimensions

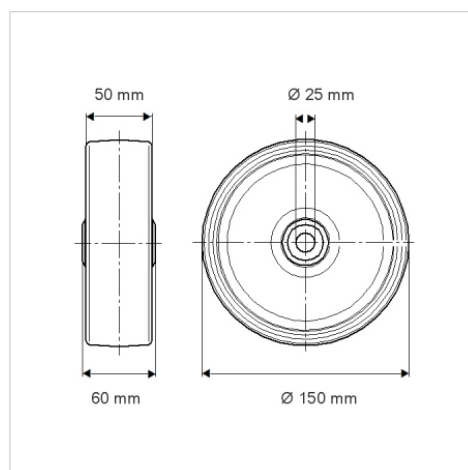

Advantages at a glance

Rezistență la rulare	● ● ● ● ○
Zgomot de mișcare	● ● ● ○ ○
Uzare	● ● ● ● ○
Protecție împotriva ruginii	● ● ● ○ ○

Structure & Mounting

