

NOVATECH

FTP150x60-Ø25 HL60

EAN 4031582329520

Jantă din fontă, suprafață de rulare din poliuretan turnat, rulment cu bile

TENTE

BETTER MOBILITY. BETTER LIFE.



Picture may differ from original product

Date Tehnice

Diametrul roții	150 mm
Lățimea roții	60 mm
Alezaj butuc	25 mm
Lungime butuc	60 mm
Temperatura	- 10 / + 60 °C
Standard	EN 12533
Greutate	3.94 kg
Rigiditatea suprafeței de rulare	Shore D 42
Sarcină dinamică	800 kg
Sarcină statică	1600 kg

Dimensions

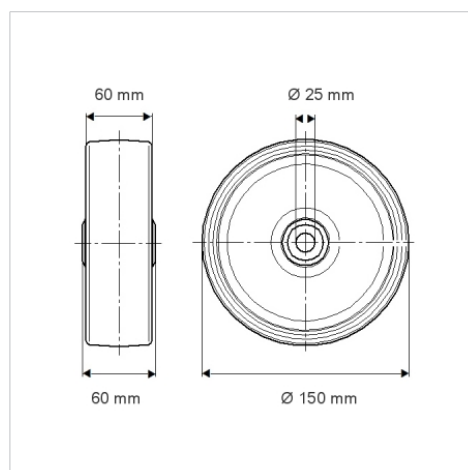

Advantages at a glance

Rezistență la rulare	● ● ● ● ○
Zgomot de mișcare	● ● ● ○ ○
Uzare	● ● ● ● ○
Protecție împotriva ruginii	● ● ● ○ ○

Structure & Mounting

