

NOVATECH

FTP160x50-Ø20 HL60

EAN 4031582329551

Telo tocka napravljeno od livenog gvozdja, Omotac: poliuretan, precizni kuglicni lezaj

TENTE

BETTER MOBILITY. BETTER LIFE.



Picture may differ from original product

Tehnicki podaci

Precnik tocka.	160 mm
Sirina gazista.	50 mm
Otvor za osovinu Ø	20 mm
Duzina glavcine.	60 mm
Temperatura	- 10 / + 60 °C
Standard	EN 12533
Tezina	2.565 kg
Tvrdoca omotaca	Shore D 42
Dinamicka nosivost.	900 kg
Staticka nosivost.	1800 kg

Dimensions

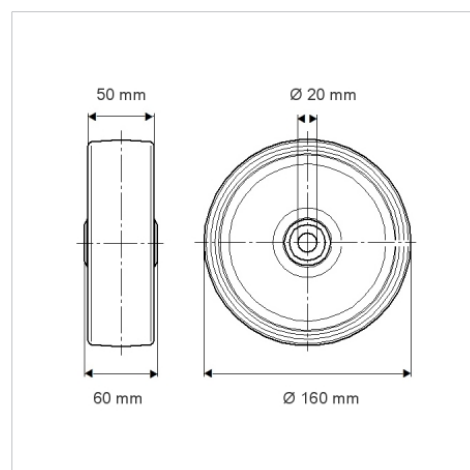

Advantages at a glance

Otpor okretanju	● ● ● ● ○
Buka pri okretanju	● ● ● ○ ○
trenje , habanje	● ● ● ● ○
zastita od korozije	● ● ● ○ ○

Structure & Mounting

