

NOVATECH

FTP200x50-Ø25 HL60

EAN 4031582329650

Hjulfælg: Støbegods, Hjulbane: Polyuretan, DIN-kugleleje



BETTER MOBILITY. BETTER LIFE.



Illustrationen kan afvige fra originalen

Tekniske data

Hjul-Ø	200 mm
Hjulbredde	50 mm
Boring-Ø	25 mm
Navlængde	60 mm
Temperaturinterval	- 10 / + 60 °C
Standard	EN 12533
Vægt	4.047 kg
Hjulbane hårdhed	Shore D 42
Belastning (dynamisk)	1000 kg
Belastning (statisk)	2000 kg

Dimensioner

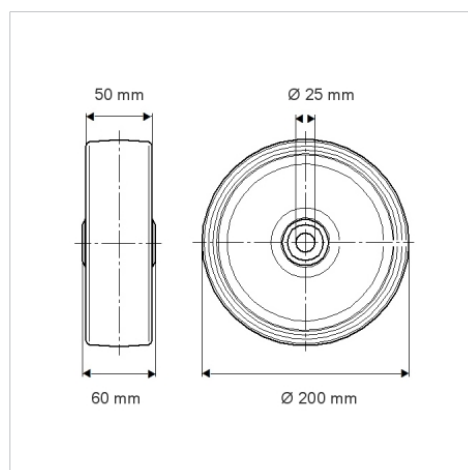

Egenskaber/fordele

Rullemodstand	● ● ● ● ○
Kørselsstøj	● ● ● ○ ○
Slid	● ● ● ● ○
Rustbeskyttelse	● ● ● ○ ○

Struktur og montering

