

# NOVATECH

FTP200x50-Ø25 HL60

EAN 4031582329650

Telo tocka napravljeno od livenog gvozdja, Omotac: poliuretan, precizni kuglicni lezaj

**TENTE**

BETTER MOBILITY. BETTER LIFE.



Picture may differ from original product

## Tehnicki podaci

Precnik tocka.	200 mm
Sirina gazista.	50 mm
Otvor za osovinu Ø	25 mm
Duzina glavcine.	60 mm
Temperatura	- 10 / + 60 °C
Standard	EN 12533
Tezina	4.047 kg
Tvrdoca omotaca	Shore D 42
Dinamicka nosivost.	1000 kg
Staticka nosivost.	2000 kg

## Dimensions

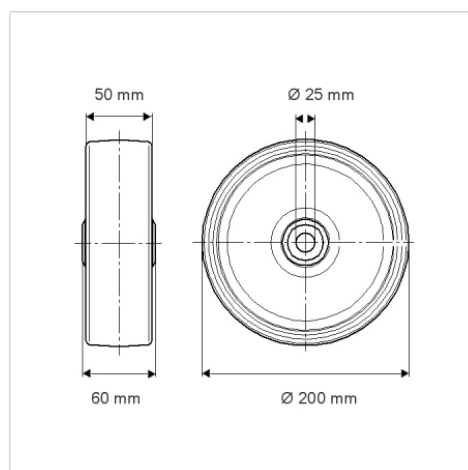

## Advantages at a glance

Otpor okretanju	● ● ● ● ○
Buka pri okretanju	● ● ● ○ ○
trenje , habanje	● ● ● ● ○
zastita od korozije	● ● ● ○ ○

## Structure & Mounting

