

NOVATECH

FTP200x60-Ø20 HL60

EAN 4031582329667

Jantă din fontă, suprafață de rulare din poliuretan turnat, rulment cu bile

TENTE

BETTER MOBILITY. BETTER LIFE.



Picture may differ from original product

Date Tehnice

Diametrul roții	200 mm
Lățimea roții	60 mm
Alezaj butuc	20 mm
Lungime butuc	60 mm
Temperatura	- 10 / + 60 °C
Standard	EN 12533
Greutate	5.372 kg
Rigiditatea suprafeței de rulare	Shore D 42
Sarcină dinamică	1200 kg
Sarcină statică	2400 kg

Dimensions

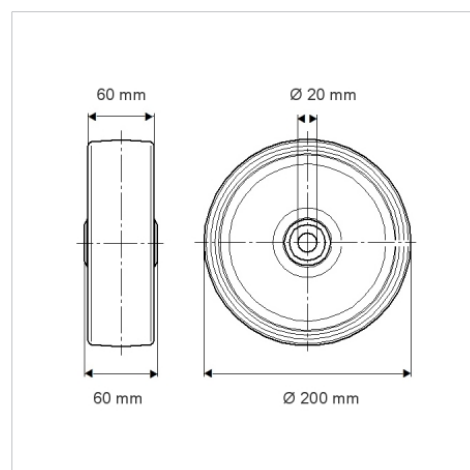

Advantages at a glance

Rezistență la rulare	● ● ● ● ○
Zgomot de mișcare	● ● ● ○ ○
Uzare	● ● ● ● ○
Protecție împotriva ruginii	● ● ● ○ ○

Structure & Mounting

