

# NOVATECH

FTP200x60-Ø25 HL60

EAN 4031582329674

Hjulfælg: Støbegods, Hjulbane: Polyuretan, DIN-kugleleje



BETTER MOBILITY. BETTER LIFE.



Illustrationen kan afvige fra originalen

## Tekniske data

Hjul-Ø	200 mm
Hjulbredde	60 mm
Boring-Ø	25 mm
Navlængde	60 mm
Temperaturinterval	- 10 / + 60 °C
Standard	EN 12533
Vægt	5.347 kg
Hjulbane hårdhed	Shore D 42
Belastning (dynamisk)	1200 kg
Belastning (statisk)	2400 kg

## Dimensioner

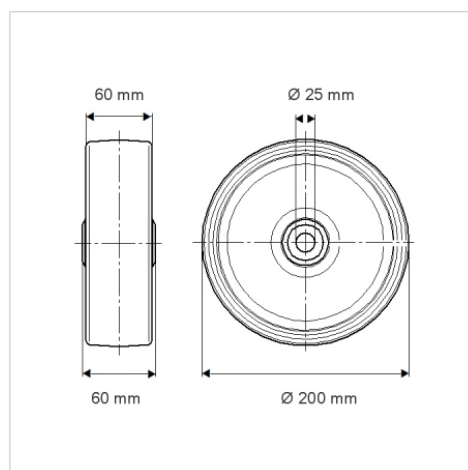

## Egenskaber/fordele

Rullemodstand	● ● ● ● ○
Kørselsstøj	● ● ● ○ ○
Slid	● ● ● ● ○
Rustbeskyttelse	● ● ● ○ ○

## Struktur og montering

