

NOVATECH

FTP250x60-Ø25 HL62

EAN 4031582331066

Riteņa centrs izgatavots no čuguna, protektors: poliuretāns, izliets, augstas precizitātes lodīšu gultnis



BETTER MOBILITY. BETTER LIFE.



Picture may differ from original product

Tehniskie dati

Riteņa diametrs	250 mm
Riteņa platums	60 mm
Riteņa ass Ø	25 mm
Rumbas platums	62 mm
Temperatūra	- 10 / + 60 °C
Standarts	EN 12533
Svars	7.123 kg
Kontaktslāņa cietība	Shore D 42
Kravnesība - kustībā	1400 kg
Kravnesība - miera stāvoklī	2800 kg

Dimensions

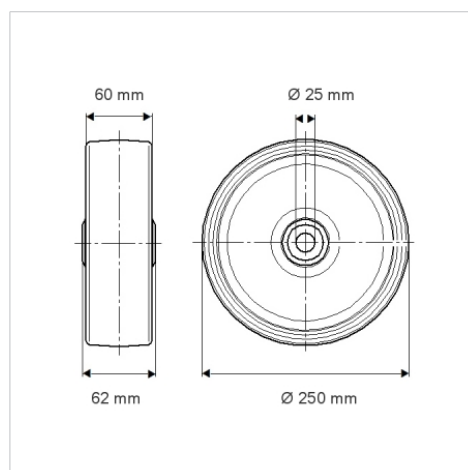

Advantages at a glance

Riteņa izturība	● ● ● ● ○
Kustības troksnis	● ● ● ○ ○
Berze	● ● ● ● ○
Rūsēšanas aizsardzība	● ● ● ○ ○

Structure & Mounting

