

NOVATECH

FTP250x80-Ø25 HL92

EAN 4031582319415

Wheel center made of cast iron, Tread: Polyurethane, casted, precision ball bearing



BETTER MOBILITY. BETTER LIFE.



Picture may differ from original product

Technical Data

Wheel diameter	250 mm
Wheel width	80 mm
Axle Hole-Ø	25 mm
Hub length	92 mm
Temperature	- 10 / + 60 °C
Standard	EN 12533
Weight	9.314 kg
Hardness of tread	Shore D 42
Load capacity (dynamic)	1800 kg
Load capacity (static)	3600 kg

Dimensions

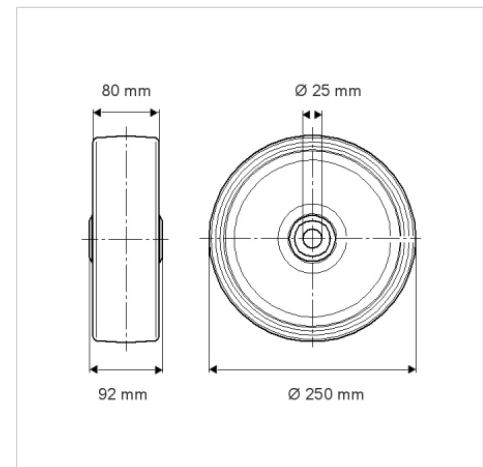

Structure & Mounting

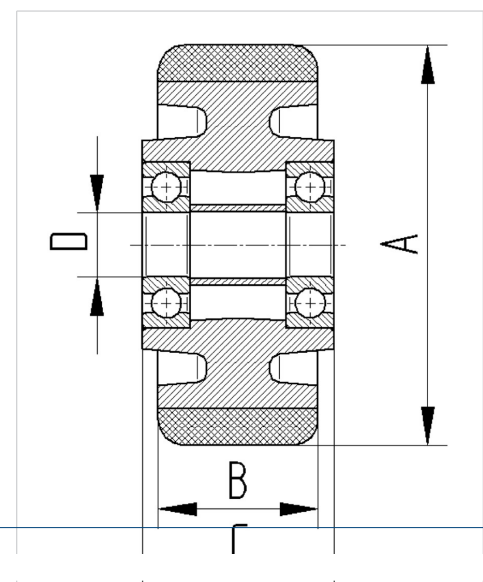

Advantages at a glance

Roll performance	● ● ● ● ○
Movement noise	● ● ● ○ ○
Attrition	● ● ● ○ ○
Corrosion resistance	● ● ● ○ ○