

# NOVATECH

FTP250x80-Ø30 HL90

EAN 4031582319422

Jantă din fontă, suprafață de rulare din poliuretan turnat, rulment cu bile

**TENTE**

BETTER MOBILITY. BETTER LIFE.



Picture may differ from original product

## Date Tehnice

Diametrul roții	250 mm
Lățimea roții	80 mm
Alezaj butuc	30 mm
Lungime butuc	90 mm
Temperatura	- 10 / + 60 °C
Standard	EN 12533
Greutate	9.262 kg
Rigiditatea suprafeței de rulare	Shore D 42
Sarcină dinamică	1800 kg
Sarcină statică	3600 kg

## Dimensions

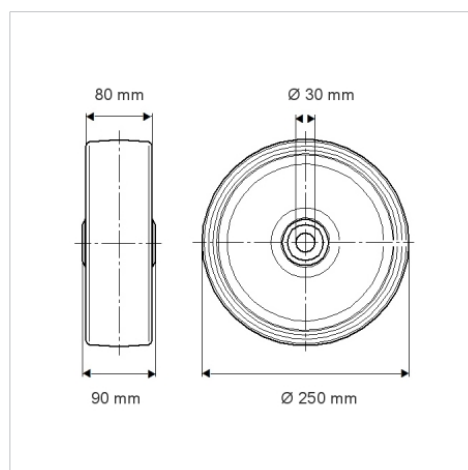

## Advantages at a glance

Rezistență la rulare	● ● ● ● ○
Zgomot de mișcare	● ● ● ○ ○
Uzare	● ● ● ● ○
Protecție împotriva ruginii	● ● ● ○ ○

## Structure & Mounting

