

NOVATECH

FTP250x80-Ø30 HL90

EAN 4031582319422

Telo točka napravljeno od livenog gvozdja, Omotac: poliuretan, precizni kuglicni lezaj

TENTE

BETTER MOBILITY. BETTER LIFE.



Picture may differ from original product

Tehnicki podaci

Precnik tocka.	250 mm
Sirina gazista.	80 mm
Otvor za osovinu Ø	30 mm
Duzina glavcine.	90 mm
Temperatura	- 10 / + 60 °C
Standard	EN 12533
Tezina	9.262 kg
Tvrdoca omotaca	Shore D 42
Dinamicka nosivost.	1800 kg
Staticka nosivost.	3600 kg

Advantages at a glance

Otpor okretanju	● ● ● ● ○
Buka pri okretanju	● ● ● ○ ○
trenje , habanje	● ● ● ● ○
zastita od korozije	● ● ● ○ ○

Dimensions

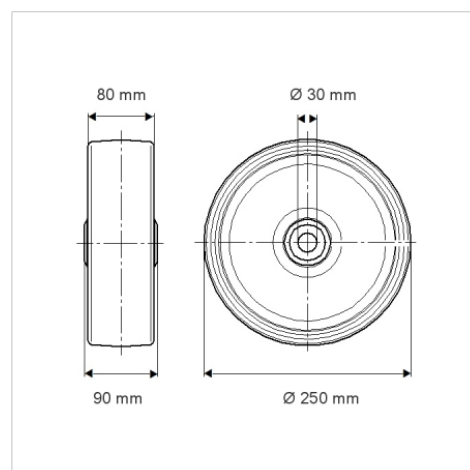

Structure & Mounting

