

NOVATECH

FTP300x100-Ø40 HL120

EAN 4031582319439

Jantă din fontă, suprafață de rulare din poliuretan turnat, rulment cu bile

TENTE

BETTER MOBILITY. BETTER LIFE.



Picture may differ from original product

Date Tehnice

Diametrul roții	300 mm
Lățimea roții	100 mm
Alezaj butuc	40 mm
Lungime butuc	120 mm
Temperatura	- 10 / + 60 °C
Standard	EN 12533
Greutate	18.81 kg
Rigiditatea suprafeței de rulare	Shore D 42
Sarcină dinamică	2600 kg
Sarcină statică	5200 kg

Dimensions

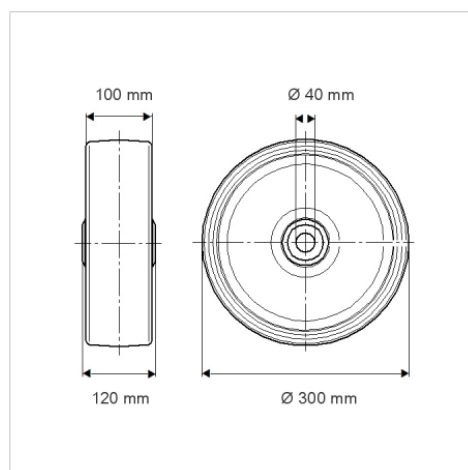

Advantages at a glance

Rezistență la rulare	● ● ● ● ○
Zgomot de mișcare	● ● ● ○ ○
Uzare	● ● ● ● ○
Protecție împotriva ruginii	● ● ● ○ ○

Structure & Mounting

