

NOVATECH

FTP300x50-Ø30 HL60

EAN 4031582319446

Wheel centre made of cast iron, Tread: Polyurethane, casted, precision ball bearing



BETTER MOBILITY. BETTER LIFE.



Picture may differ from original product

Technical Data

Wheel diameter	300 mm
Wheel width	50 mm
Axle Hole-Ø	30 mm
Hub length	60 mm
Temperature	- 10 / + 60 °C
Standard	EN 12533
Weight	11.086 kg
Hardness of tread	Shore D 42
Load capacity	1400 kg
Load capacity (static)	2800 kg

Dimensions

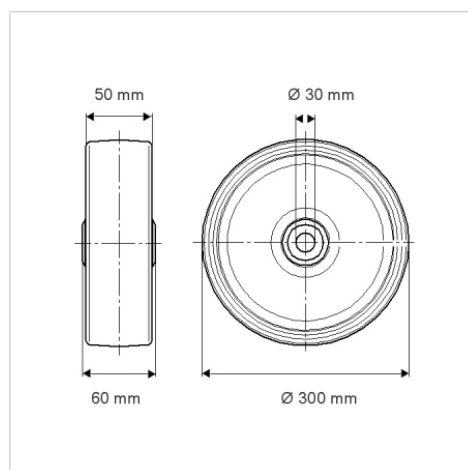

Advantages at a glance

Roll performance	● ● ● ● ○
Movement noise	● ● ● ○ ○
Attrition	● ● ● ● ○
Corrosion resistance	● ● ● ○ ○

Structure & Mounting

