

NOVATECH

FTP300x50-Ø30 HL60

EAN 4031582319446

Jantă din fontă, suprafață de rulare din poliuretan turnat, rulment cu bile

TENTE

BETTER MOBILITY. BETTER LIFE.



Picture may differ from original product

Date Tehnice

Diametrul roții	300 mm
Lățimea roții	50 mm
Alezaj butuc	30 mm
Lungime butuc	60 mm
Temperatura	- 10 / + 60 °C
Standard	EN 12533
Greutate	11.086 kg
Rigiditatea suprafeței de rulare	Shore D 42
Sarcină dinamică	1400 kg
Sarcină statică	2800 kg

Dimensions

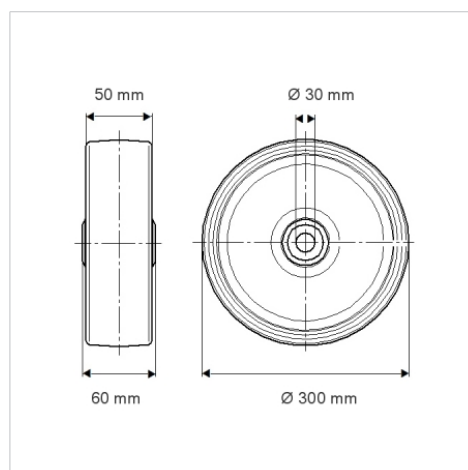

Advantages at a glance

Rezistență la rulare	● ● ● ● ○
Zgomot de mișcare	● ● ● ○ ○
Uzare	● ● ● ● ○
Protecție împotriva ruginii	● ● ● ○ ○

Structure & Mounting

