

NOVATECH

FTP300x80-Ø30 HL92

EAN 4031582331097

Hjulfælg: Støbegods, Hjulbane: Polyuretan, DIN-kugleleje



BETTER MOBILITY. BETTER LIFE.



Illustrationen kan afvige fra originalen

Tekniske data

Hjul-Ø	300 mm
Hjulbredde	80 mm
Boring-Ø	30 mm
Navlængde	92 mm
Temperaturinterval	- 10 / + 60 °C
Standard	EN 12533
Vægt	14.768 kg
Hjulbane hårdhed	Shore D 42
Belastning (dynamisk)	2000 kg
Belastning (statisk)	4000 kg

Dimensioner

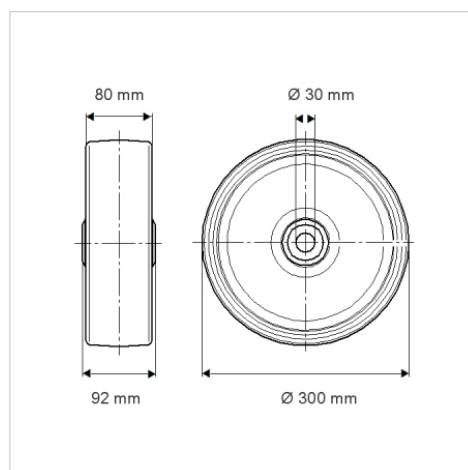

Egenskaber/fordele

Rullemodstand	● ● ● ● ○
Kørselsstøj	● ● ● ○ ○
Slid	● ● ● ● ○
Rustbeskyttelse	● ● ● ○ ○

Struktur og montering

