

# NOVATECH

FTP300x80-Ø30 HL92

EAN 4031582331097

Riteņa centrs izgatavots no čuguna, protektors: poliuretāns, izliets, augstas precizitātes lodīšu gultnis



BETTER MOBILITY. BETTER LIFE.



Picture may differ from original product

## Tehniskie dati

Riteņa diametrs	300 mm
Riteņa platums	80 mm
Riteņa ass Ø	30 mm
Rumbas platums	92 mm
Temperatūra	- 10 / + 60 °C
Standarts	EN 12533
Svars	14.768 kg
Kontaktslāņa cietība	Shore D 42
Kravnesība - kustībā	2000 kg
Kravnesība - miera stāvoklī	4000 kg

## Dimensions

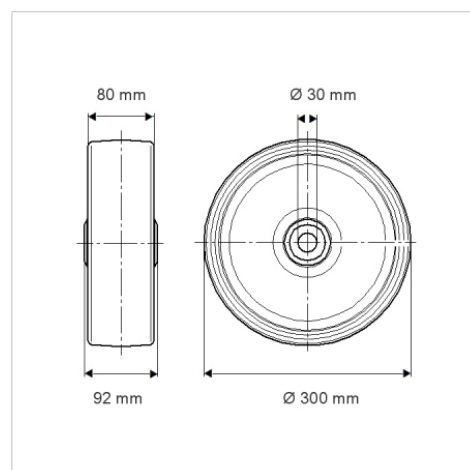

## Advantages at a glance

Riteņa izturība	● ● ● ● ○
Kustības troksnis	● ● ● ○ ○
Berze	● ● ● ● ○
Rūsēšanas aizsardzība	● ● ● ○ ○

## Structure & Mounting

