

NOVATECH

FTP300x80-Ø30 HL92

EAN 4031582331097

Jantă din fontă, suprafață de rulare din poliuretan turnat, rulment cu bile

TENTE

BETTER MOBILITY. BETTER LIFE.



Picture may differ from original product

Date Tehnice

Diametrul roții	300 mm
Lățimea roții	80 mm
Alezaj butuc	30 mm
Lungime butuc	92 mm
Temperatura	- 10 / + 60 °C
Standard	EN 12533
Greutate	14.768 kg
Rigiditatea suprafeței de rulare	Shore D 42
Sarcină dinamică	2000 kg
Sarcină statică	4000 kg

Dimensions

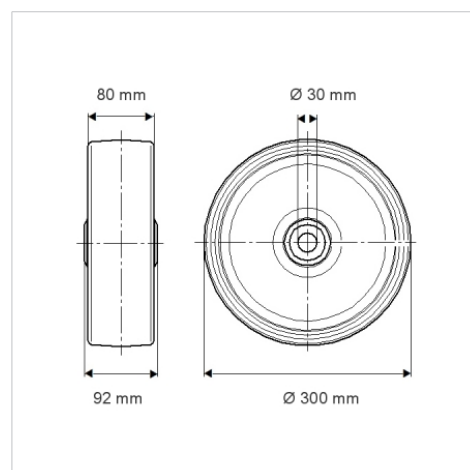

Advantages at a glance

Rezistență la rulare	● ● ● ● ○
Zgomot de mișcare	● ● ● ○ ○
Uzare	● ● ● ● ○
Protecție împotriva ruginii	● ● ● ○ ○

Structure & Mounting

