

# NOVATECH

FTP400x80-Ø40 HL90

EAN 4031582319507

주철로 만든 휠 중심, 트레드: 폴리우레탄, 주조 처리, 정밀 볼 베어링



BETTER MOBILITY. BETTER LIFE.



Picture may differ from original product

## 기술 데이터

휠 직경	400 mm
휠 폭	80 mm
축 홀-Ø	40 mm
허브 길이	90 mm
온도	- 10 / + 60 °C
표준	EN 12533
무게	23.598 kg
트레드 경도	Shore D 42
동하중	2500 kg
정지하중	5000 kg

## Dimensions

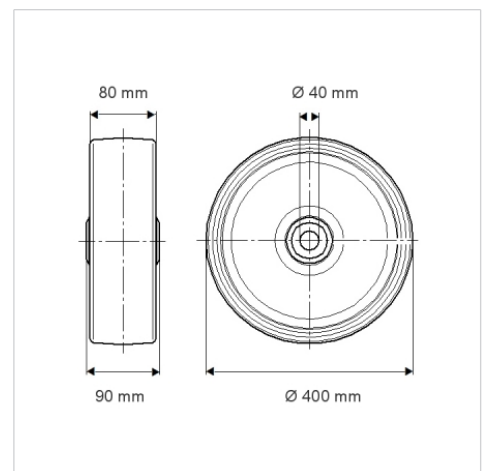

## Structure & Mounting

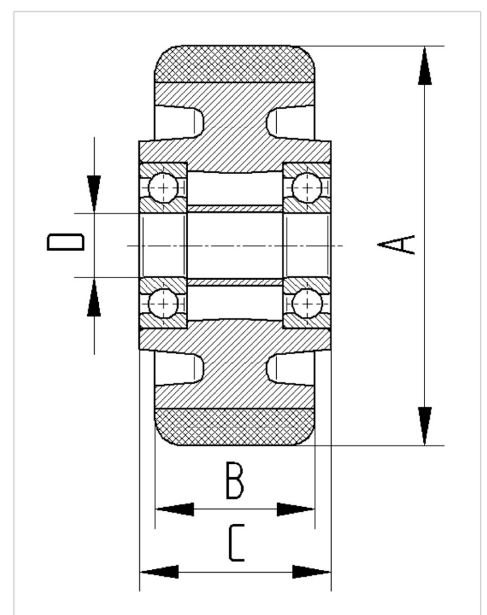

## Advantages at a glance

롤 저항성	● ● ● ● ○
이동 소음	● ● ● ○ ○
마찰	● ● ● ● ○
부식 방지	● ● ● ○ ○