

NOVATECH

FTP400x80-Ø40 HL90

EAN 4031582319507

Jantă din fontă, suprafață de rulare din poliuretan turnat, rulment cu bile

TENTE

BETTER MOBILITY. BETTER LIFE.



Picture may differ from original product

Date Tehnice

Diametrul roții	400 mm
Lățimea roții	80 mm
Alezaj butuc	40 mm
Lungime butuc	90 mm
Temperatura	- 10 / + 60 °C
Standard	EN 12533
Greutate	23.598 kg
Rigiditatea suprafeței de rulare	Shore D 42
Sarcină dinamică	2500 kg
Sarcină statică	5000 kg

Dimensions

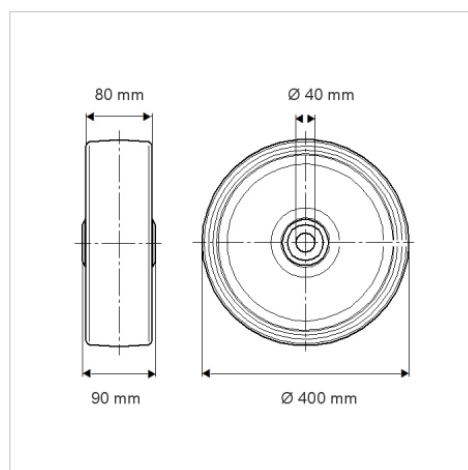

Advantages at a glance

Rezistență la rulare	● ● ● ● ○
Zgomot de mișcare	● ● ● ○ ○
Uzare	● ● ● ● ○
Protecție împotriva ruginii	● ● ● ○ ○

Structure & Mounting

